

Molteni & C

LOGOS — VINCENT VAN DUYSSEN 2024

1—
9



Modularity, functionality, and lightness are the hallmarks of Molteni&C's first fully modular living room wall unit system. This innovative system, designed by Vincent Van Duysen, offers unparalleled versatility and customization, both in composition and finishes. Logos emerges as a centerpiece in the 2024 Molteni&C Collection. Its "sleek and simple" modular composition, combined with a harmonious blend of materials, offers endless configurations to suit individual tastes and functional needs. The design introduces a fresh approach to space, characterized by the sleek vertical dividers that define its modularity and aesthetics. Whether placed on the ground, mounted on the wall, or suspended with a trestle base in metal finishes, Logos adapts effortlessly to any setting. Vertical flexibility is key, as modules can vary in height to suit the functionality of each wall area. The sides become a defining feature, seamlessly connecting the base with the upper shelf. A touch of illumination can elevate this wall unit system further, with warm 2700 lumen LED top lighting set in the rear to create captivating reflections that interact with the diverse materials and finishes.

DATASHEET

REGISTERED
DESIGN

IV.2024

FINISHES

Finishes

All finishes in the Logos project were chosen to allow for the utmost versatility in colours and materials, in full harmony with the product design and construction characteristics.

Notes

Any requests for finishes other than those listed below can be accepted only following confirmation of feasibility from the Molteni&C technical department.

Molteni&C

2—
9

finishes	matt lacquer colours	3D matt lacquer colours	wood	glossy lacquer colours	pewter colour / iris	transparent extra clear glass	stopsol glasses	BLEND fabric	bronze mirror	marble (matt finish)	black melamine	grey saffiano
components												
module back	•		•	•				•	•			
structure cover (under top)					•						•	
side panel th 14 / base th 40	•		•									
glass side panel th 14 / glass door					•							
wooden hinged door th 25 / drawer fronts th 25 / central shelf above drawer th 20	•	• excluding shelf	•	•								
TV module back	•		•					•				
glass shelf th 8						•						
wooden shelf th 14	•		•	•								
glass shelf with profile th 14					•							
internal drawer unit	•		•									
single material top th 40 / TV module central shelf th 40	•		•							•		
top with frame th 40					•							
metal base					•							
drawer interior												•

colours

Matt lacquer
3D matt lacquer
BC chalk white
PE pearl
DN dune
PL platinum
NE black
AT anthracite
SE mustard
SI silica
DO dolomite grey
AL clay
MK moka
CZ light blue grey
SA sand
RU ruby
PX pewter colour
RX copper
TO dove grey
PR petroleum blue
BG burgundy
LS london sky
SU stardust
ML moonlight
SP spice
PG pine green
AW almond white
CP cappuccino
IX iris

Glossy lacquer
BC chalk white
PE pearl
DN dune
PL platinum
NE black
AT anthracite
SE mustard
SI silica
DO dolomite grey
AL clay
MK moka
CZ light blue grey
SA sand
RU ruby
PX pewter colour
RX copper
TO dove grey
PR petroleum blue
BG burgundy
LS london sky
SU stardust
ML moonlight
SP spice
PG pine green
AW almond white
CP cappuccino
IX iris

Woods
RF graphite oak
RN black oak
RC coffee oak
RS sunrise oak
EU eucalyptus

Stopsol glasses
transparent
bronze
silver

BLEND fabric
bark brown
moss green
olive green
oxide orange
vanilla

Marble (matt finish)
breccia capraia
calacatta
emperador dark
Sahara noir
black marquina
red lepanto

DATASHEET

REGISTERED
DESIGN

IV.2024

moltenigroup.com

Dimensions in millimeters and inches. The right to discontinue and make changes is reserved. This information is based on the latest product information available at the time of printing.

STRUCTURAL MODULARITY H 338 / 487 / 636

With these modules, compositions with height differences can be created without doubling the side panel.

Notes

No reductions of any kind are allowed.
The following may not be used in hanging compositions:
- monochrome marble top th 40
- glass side panel

Maximum composition size with base 2934 mm

Modules with glass side panels can be closed with hinged doors and fitted with shelves.

Side view

Floor-standing structures / Base

Wall-mounted structures

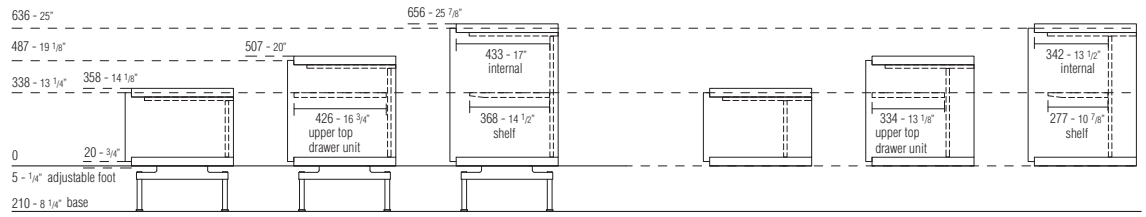

Front view / plan

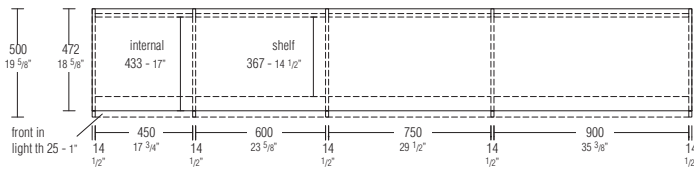
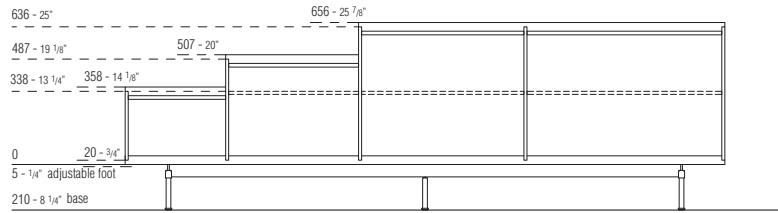

DATASHEET

REGISTERED
DESIGN

IV.2024

MODULARITY H 1230

In the 1230 height, a special element W 1800 is available for inserting a television:
TV module.
The change in height is provided for by combining two compositions.

Notes

No reductions of any kind are allowed.
The following may not be used in hanging compositions:
- monochrome marble top th 40
- glass side panel
- internal drawer units

Maximum composition size with base 2934 mm

Modules with glass side panels can be closed with hinged doors and fitted with shelves.

Side view

Floor-standing structures / Base

Wall-mounted structures

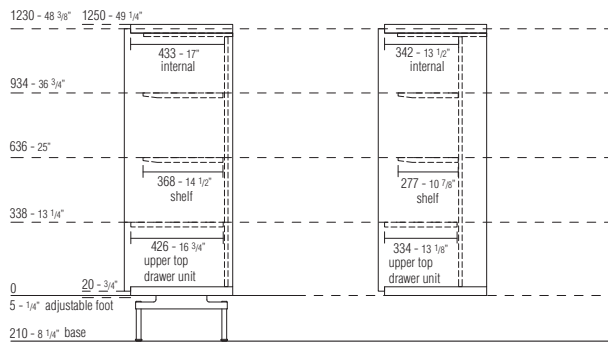

Front view / plan

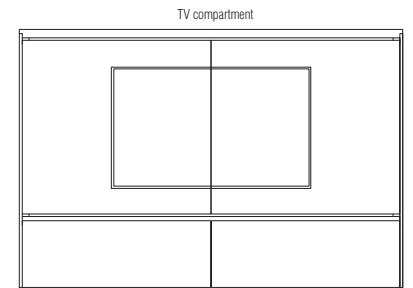
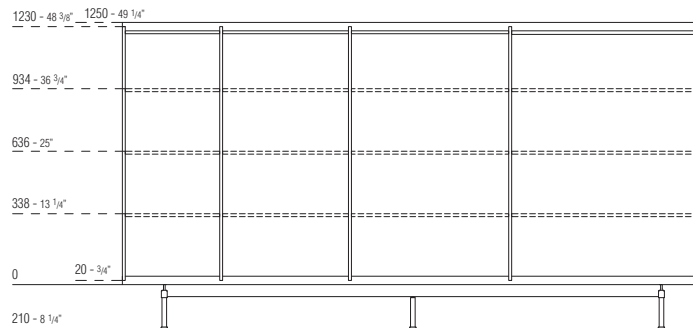

The TV module is available only in the wall-mounted or floor-standing version with adjustable feet.

Never place it on a base

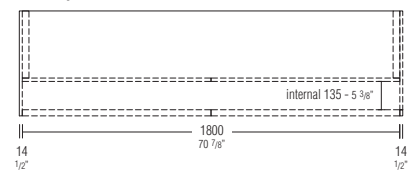
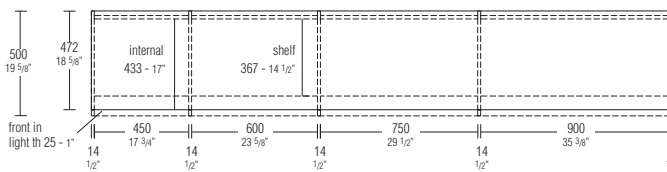

TAPE COMPARTMENT / WIRE PASSAGE

Logos is designed to accommodate HI-FI systems both visibly in the open compartments and hidden in dedicated TAPE compartments.
The sections below illustrate possible solutions.

Notes

The position of the wire hole in the top is always at the centre of the underlying module to be wired, in both the monochrome version and the version with a metal frame.
Mirror and fabric back panels cannot be used with the TAPE compartment.

Molteni & C

5
9

Wire hole position in the top

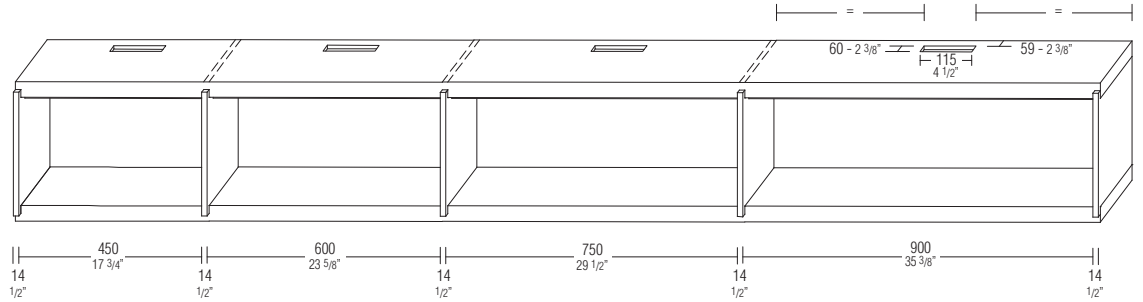

TAPE compartment sections / wire passage

Floor-standing / on a base

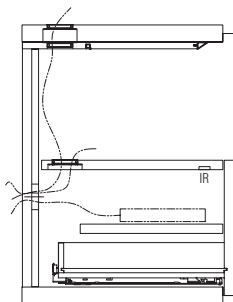
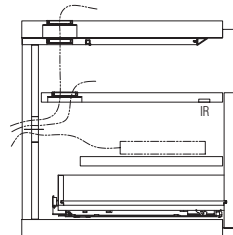
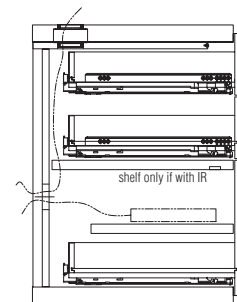
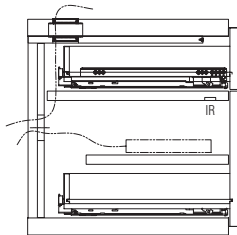
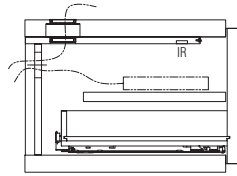

Wall-mounted

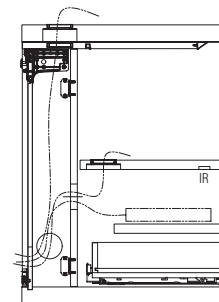
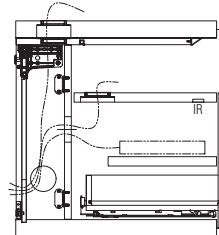
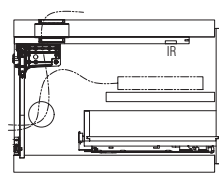

DATASHEET

REGISTERED
DESIGN

IV.2024

MODULARITY H 1230 - TV MODULE

The examples below show how the TV module makes it simple and functional to mount the TV (avoiding work on the walls) and connect HI-FI devices. The module provides integrated and elegant solutions in all living or dining areas.

Notes

The TV module is available only in the wall-mounted or floor-standing version with adjustable.
Never place it on a base.

TAPE compartment sections / wire passage

Molteni & C

Floor-standing / wall-mounted
with TAPE compartment

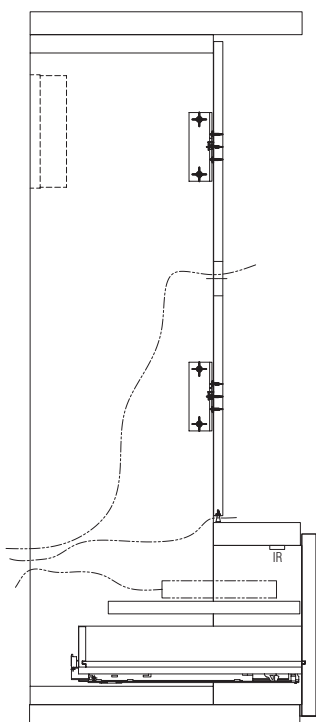

Floor-standing / wall-mounted
without TAPE compartment

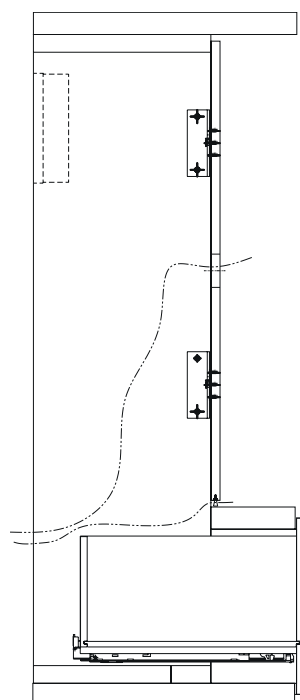

6—
9

DATASHEET

REGISTERED
DESIGN

IV.2024

TV MODULE FOR FLOOR-STANDING COMPOSITIONS

In the Logos system, a TV module is available for mounting televisions up to 75 inches.

Two TV module versions are available:
- With lower drawers (TVs up to 65 inches)
- Open (TVs up to 75 inches)

The TV stand module can be used in the centre or to the side in combination with other modules, or individually, closed in with side panels.

Notes

No reductions of any kind are possible.

With TV modules, the change in height is provided for by combining two compositions. The TV module cannot be placed on the metal base.

The version with lower drawers always includes a th 40 central shelf, available in the finishes of the top.

Not available with glass side panels.

The TAPE compartment can be used in the drawers (as shown in the diagram on page 6), adding the price of the shelf and TV receiver.

Molteni & C

7—
9

Version with lower drawers

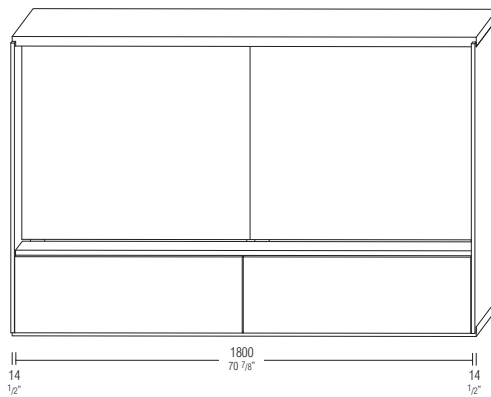

SIDE SECTION

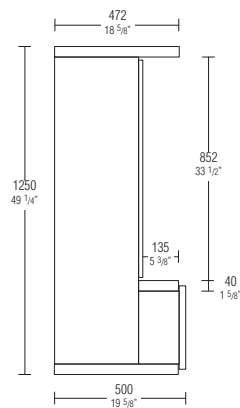

Open version

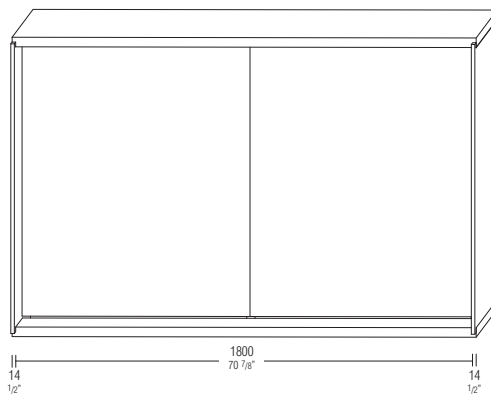

SIDE SECTION

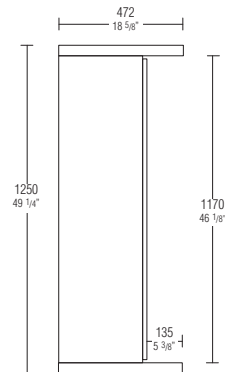

DATASHEET

REGISTERED
DESIGN

IV.2024

TV MODULE FOR WALL-MOUNTED COMPOSITIONS

In the Logos system, a TV module is available for mounting televisions up to 75 inches.

Two TV module versions are available:
- With lower drawers (TVs up to 65 inches)
- Open (TVs up to 75 inches)

The TV stand module can be used in the centre or to the side in combination with other modules, or individually, closed in with side panels.

Notes

No reductions of any kind are possible.

With TV modules, the change in height is provided for by combining two compositions. The version with lower drawers always includes a th 40 central shelf, available in the finishes of the top.

Not available with glass side panels.

The TAPE compartment can be used in the drawers (as shown in the diagram on page 6), adding the price of the shelf and TV receiver.

Molteni & C

8
9

Version with lower drawers

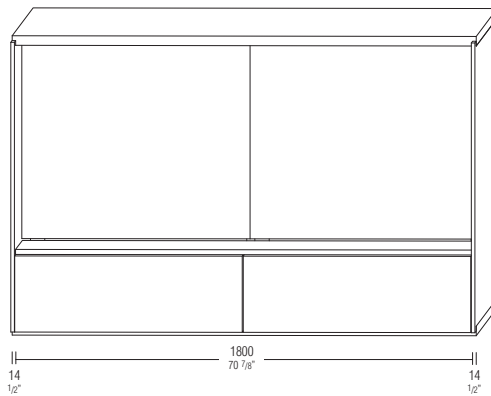

SIDE SECTION

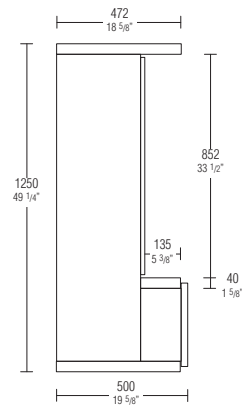

Open version

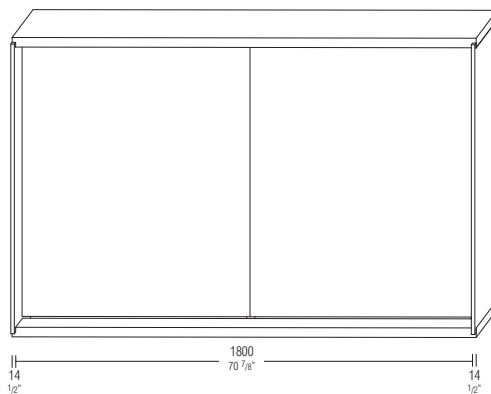

SIDE SECTION

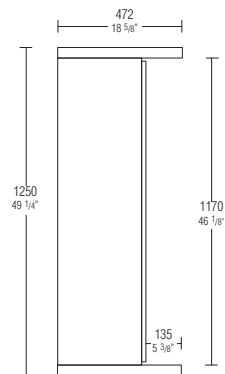

DATASHEET

REGISTERED
DESIGN

IV.2024

COMPOSITIONS

The Logos compositions must be completed with a finishing top.
Two versions of top are available:
- Single material th 40
- Metal frame with inserts

The tops can be equipped with a wire hole in the same finish.
The position of the wire hole is always at the centre of the underlying module to be wired,
in both the monochrome version and the version with a metal frame.
See options on page 5 for inserting the TAPE compartment.

Notes

In both versions, the top is made of a single piece up to W 2934 mm.
In compositions larger than W 2934 mm, the top must always be joined at a side panel.
The joint should be made at the side panel closest to the centre of the composition.
Due to the construction method, the joint in the frame version is visible only on the front edge.
The single material marble top th 40 cannot be used in wall-mounted compositions.

Molteni & C

9
9

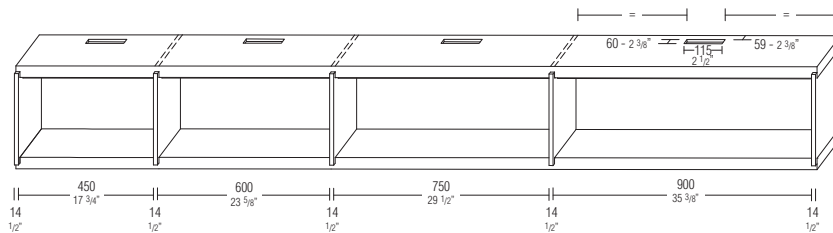
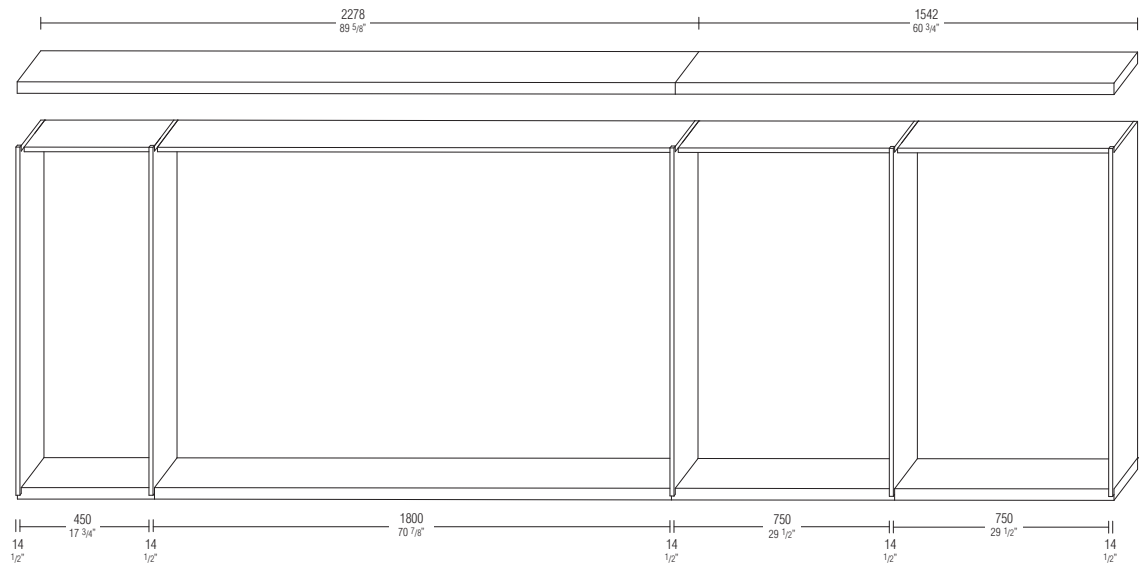
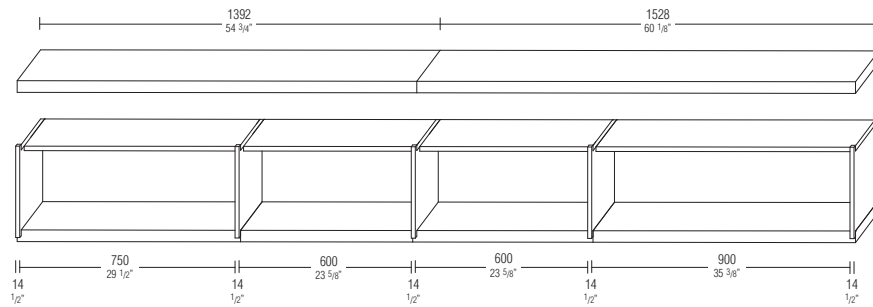

DATASHEET

REGISTERED
DESIGN

IV.2024